

More Precision.



optris[®] CT laser LT

Non-contact temperature measurement with precise aiming from -50°C to 975°C



FEATURES

- Low and high temperature measurements of smallest spots up from 0.9 mm
- NEW: Double laser aiming marks real spot location and spot size at any distance
- Optics 75:1 with selectable focus
- CT laser F (fast) for scanning of fast moving low temperature objects up from 9 ms response time
- Usable up to 85°C ambient temperature without cooling and automatic laser switch off at 50°C
- Selectable analog outputs 0/4-20mA, 0-5/10V, thermocouple type K or J
- Optional plug in digital interfaces USB, RS232, RS485, CAN or Profibus DP

General specifications	
Environmental rating	IP 65 (NEMA-4)
Ambient temperature	sensing head: -20 - 85°C (50°C with laser ON) electronics: 0 - 85°C
Storage temperature	sensing head: -40 - 85°C electronics: -40 - 85°C
Relative humidity	10 - 95%, non condensing
Vibration (sensor)	IEC 68-2-6: 3 G, 11 - 200 Hz, any axis
Shock (sensor)	IEC 68-2-27: 50 G, 11 ms, any axis
Weight	sensing head 600 g electronics 420 g
Electrical specifications	
Outputs/analog	channel 1: 0/4 - 20 mA, 0 - 5/10 V, thermocouple J, K channel 2: sensing head temperature (-40 - 85°C as 0 - 5 V or 0 - 10 V), alarm output
Alarm output	Open - collector (24 V / 50 mA)
Optional	relay: 2 x 60 V DC/42 V AC _{eff} ; 0.4 A; optically isolated
Outputs/digital (optional)	USB, RS232, RS485, CAN, Profibus DP, Ethernet
Output impedances	mA max. 500 Ω (with 5 - 36 V DC) mV min. 100 kΩ load impedance thermocouple 20 Ω
Inputs	programmable functional inputs for external emissivity adjustment, ambient temperature compensation, trigger (reset of hold functions)
Cable length	3 m (standard), 8 m, 15 m
Current draw	max. 160 mA
Power supply	8 - 36 V DC
Laser 635 nm	1mW, ON/OFF via electronic box or software

Measurement specifications	
Temperature range (scalable via programming keys or software)	-50 - 975°C
Spectral range	8 - 14 μm
Optical resolution (90% energy)	75:1 CT laser 50:1 CT laser F
Selectable focus (CT laser) ¹⁾	CF1 0.9 mm @ 70 mm
	CF2 1.9 mm @ 150 mm
	CF3 2.75 mm @ 200 mm
	CF4 5.9 mm @ 450 mm
	SF 16 mm @ 1260 mm
System accuracy (at ambient temperature 23 ±5°C)	±1% or ±1°C ^{2),3)} (CT laser) ±1.5% or ±1.5°C ^{2),3)} (CT laser F)
Repeatability (at ambient temperature 23 ±5°C)	±0.5 % or ±0.5°C ²⁾ (CT laser) ±1 % or ±1°C ²⁾ (CT laser F)
Temperature resolution (NETD)	0.1°C / 0,5°C (with CT laser F)
Response time (90% signal) ⁴⁾	9 ms (CT laser F)
	120 ms (CT laser)
Emissivity/Gain (adjustable via programming keys or software)	0.100 - 1.100
Transmissivity/Gain (adjustable via programming keys or software)	0.100 - 1.000
Signal processing (parameter adjustable via programming keys or software, respectively)	peak hold, valley hold, average; extended hold function with threshold and hysteresis

¹⁾ different spotsizes for CTlaser F (D:S = 50:1)

²⁾ whichever is greater

³⁾ at object temperatures >0°C, ε = 1

⁴⁾ with dynamic adaption at low signal levels

optris® CT laser LT

Optical specifications

SF optics 75:1

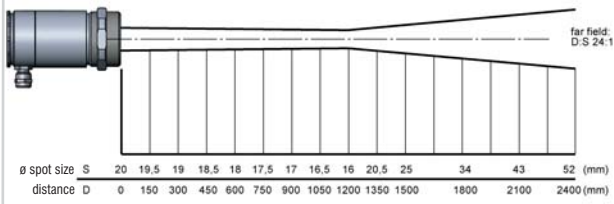

CF1 optics 75:1

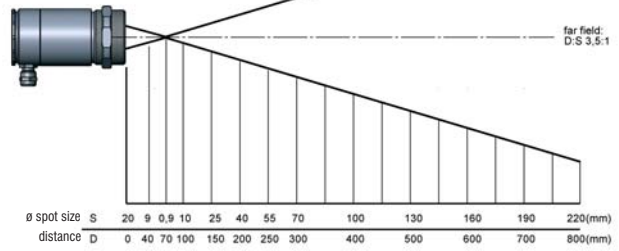

CF2 optics 75:1

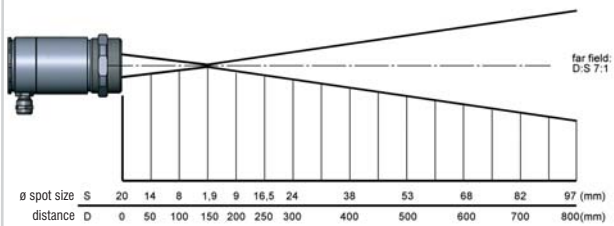

CF3 optics 75:1

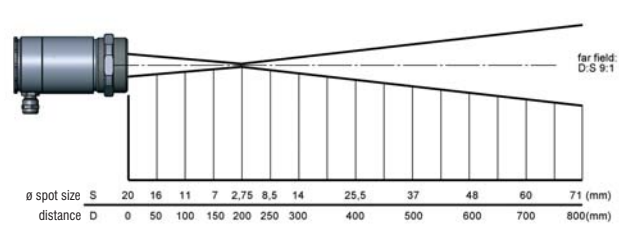

Dimensions

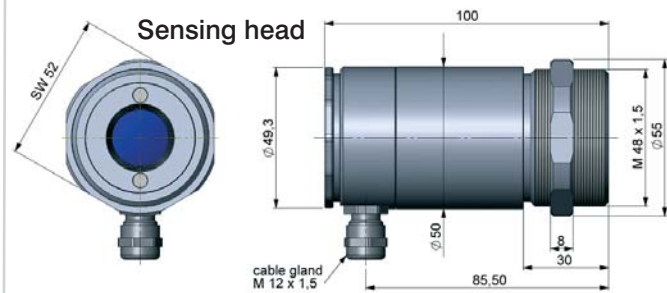

CF4 optics 75:1

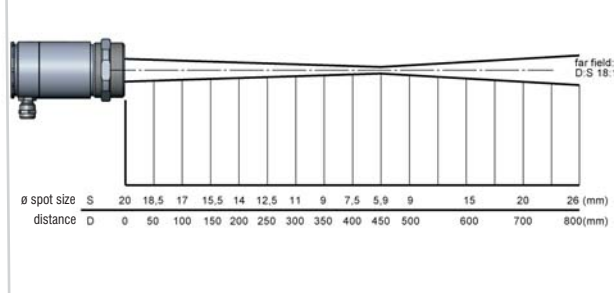

Electronics

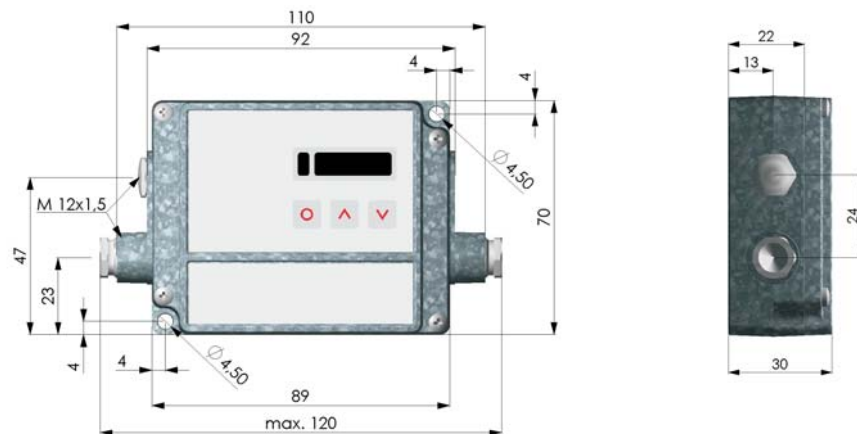

CompactConnect Software

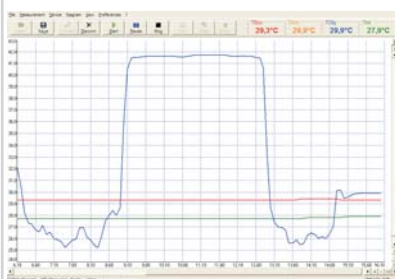

- Software for easy sensor setup and remote controlling, supports multi tasking
- Graphic display for temperature trends and automatic data logging for analysis and documentation with 1 ms response time
- Adjustment of signal processing functions and programming of outputs and functional inputs of the sensor
- Automatic emissivity adjustment
- The software CompactConnect allows to customize the sensor to application needs of the user